

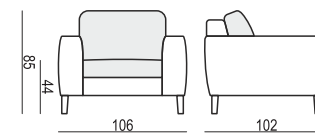

**ARMCHAIR**

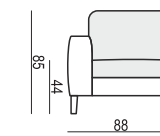

**ARMCHAIR LEFT (or RIGHT)**



**ARMCHAIR without ARMRESTS**

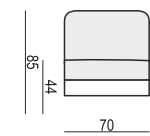

**ARMCHAIR WIDE**

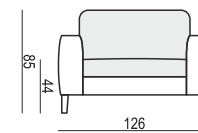

**ARMCHAIR WIDE LEFT (or RIGHT)**

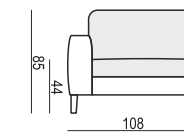

**ARMCHAIR WIDE without ARMRESTS**

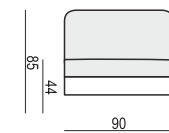

**2 SEATER**

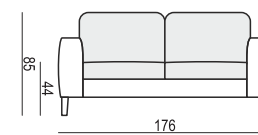

**2 SEATER LEFT (or RIGHT)**

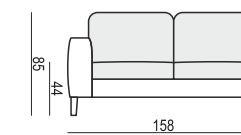

**2 SEATER without ARMRESTS**

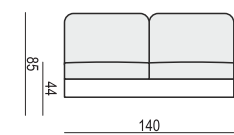

**3 SEATER**

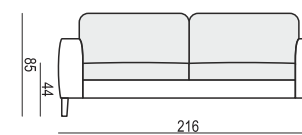

**3 SEATER LEFT (or RIGHT)**

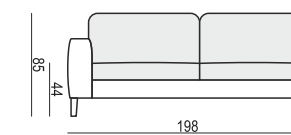

**3 SEATER without ARMRESTS**

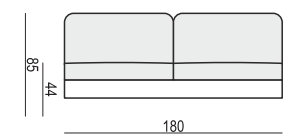

**CHAISELONGUE LEFT (or RIGHT)**

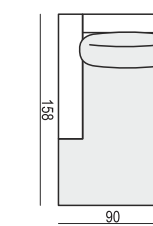

**CHAISELONGUE WIDE LEFT (or RIGHT)**

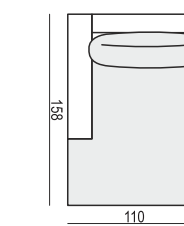

**DIVAN LEFT (or RIGHT)**

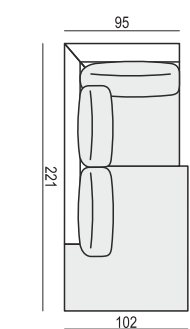

**COZY CORNER LEFT (or RIGHT)**

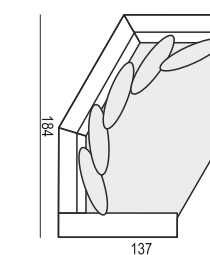

**CORNER 90° No.1**

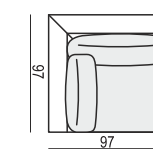

**CORNER 90° No.2**

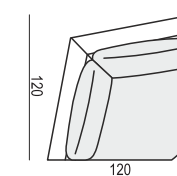

**FOOTSTOOL**

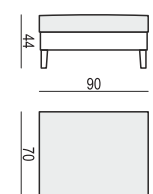

**ENDPART LEFT (or RIGHT)**  
cm 95 x 4 x 58 H

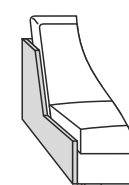

**HEADREST L-77**

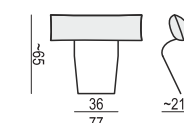

**HEADREST L-62**

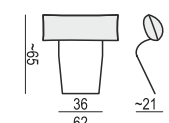

**SET 1 LEFT (or RIGHT)**  
CHAISELONGUE LEFT (or RIGHT) + 2 SEATER RIGHT (or LEFT)

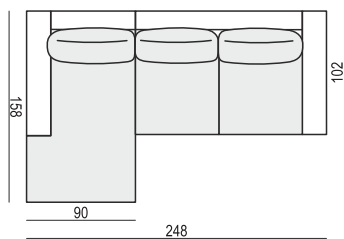

**SET 2 LEFT (or RIGHT)**  
CHAISELONGUE WIDE LEFT (or RIGHT) + 3 SEATER RIGHT (or LEFT)

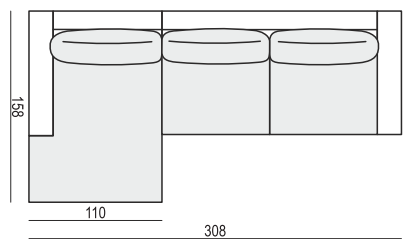

**SET 3 LEFT (or RIGHT)**  
DIVAN LEFT (or RIGHT) + 2 SEATER RIGHT (or LEFT)

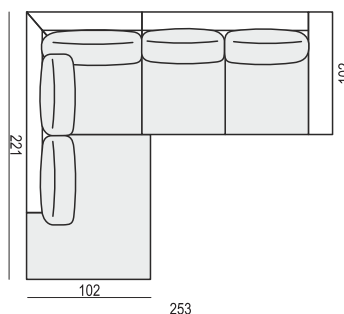

**SET 4 LEFT (or RIGHT)**  
DIVAN LEFT (or RIGHT) + 3 SEATER RIGHT (or LEFT)

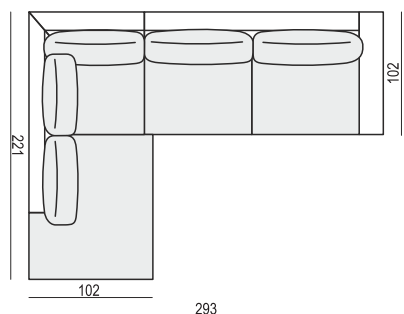

**SET 5 LEFT (or RIGHT)**  
COZY CORNER LEFT (or RIGHT) + 3 SEATER RIGHT (or LEFT)

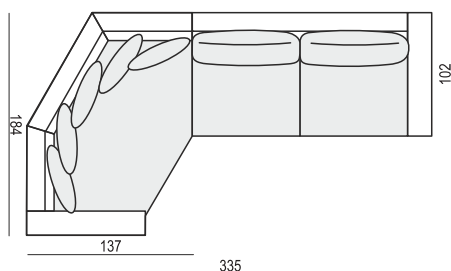

**SET 6**  
DIVAN LEFT + 2 SEATER without ARMRESTS + DIVAN RIGHT

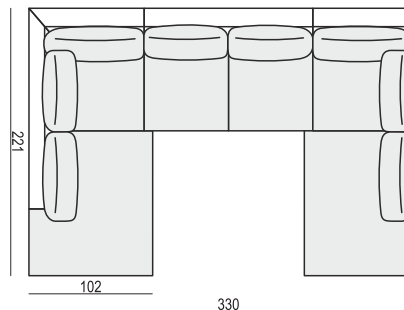

**SET 7 LEFT (or RIGHT)**  
DIVAN LEFT (or RIGHT) + 2 SEATER without ARMRESTS  
+ CHAISELONGUE RIGHT (or LEFT)

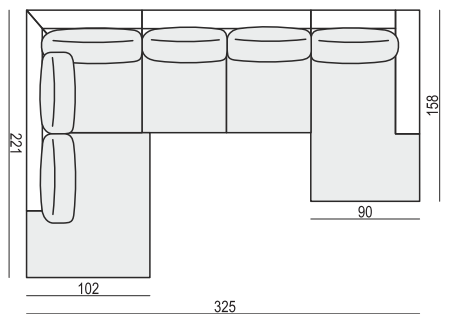

**SET 8 LEFT (or RIGHT)**  
2 SEATER LEFT (or RIGHT) + CORNER 90° No.1  
+ 3 SEATER RIGHT (or LEFT)

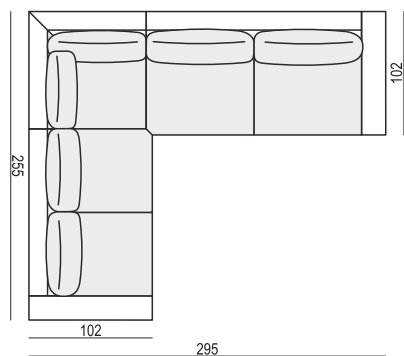

SITS reserves the right to change construction of products and components used due to improving durability of product and customer satisfaction without any further notice. Explicit ±2 cm tolerance of all elements sizes.

**SET 9 LEFT (or RIGHT)**  
2 SEATER LEFT (or RIGHT) + CORNER 90° No.2  
+ 3 SEATER RIGHT (or LEFT)

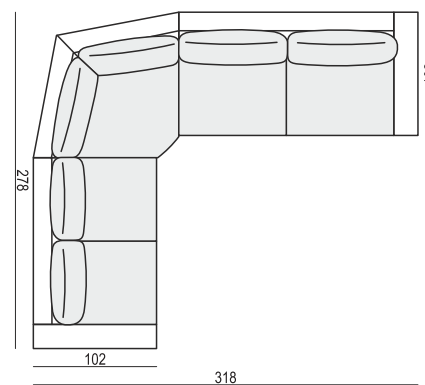

**SET 10 LEFT (or RIGHT)**  
CHAISELONGUE LEFT (or RIGHT) + 2 SEATER without ARMRESTS  
+ CORNER 90° No.1 + 2 SEATER RIGHT (or LEFT)

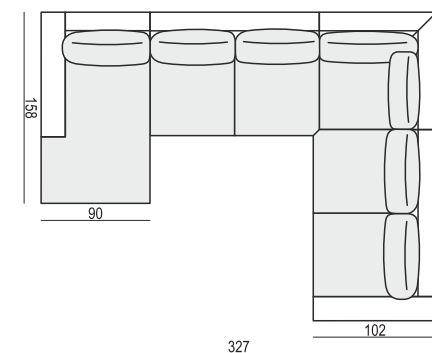

## UPHOLSTERY

**FABRIC: FC - fix cover or LCV - loose cover with velcro**

## FEET

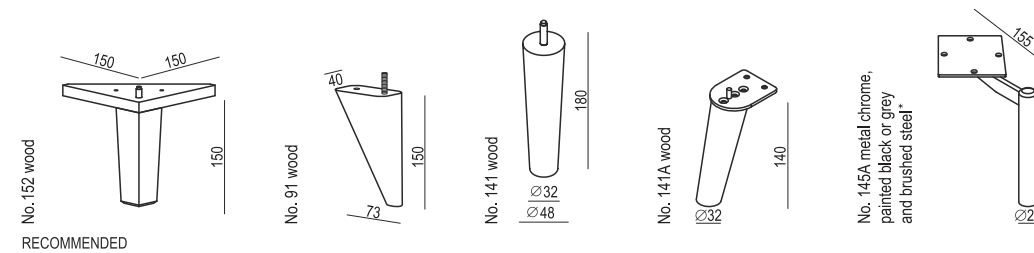

\*please check a cost of brushed steel finish with a sale representative

## STANDARD COMFORT

1. polyurethane foam/ high resilient polyurethane foam
2. silicone balls lux
3. springs
4. FSC®certified solid wood and wood based elements
5. fabric
6. FSC®certified solid wood or metal legs

## LUX COMFORT

1. polyurethane foam/ high resilient polyurethane foam
2. cushion chamber with mix of feather and silicone balls
3. springs
4. FSC®certified solid wood and wood based elements
5. fabric
6. FSC®certified solid wood or metal legs