

ARMCHAIR

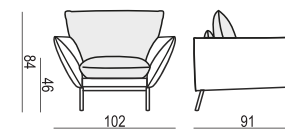

2 SEATER

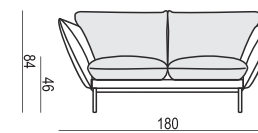

3 SEATER

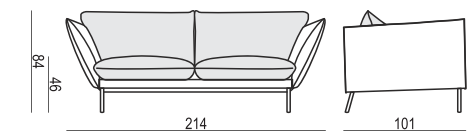

FOOTSTOOL

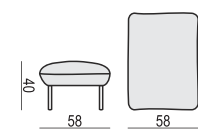

HEADREST L-77

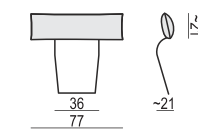

HEADREST L-62

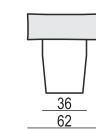

SET 1 LEFT (or RIGHT)
CHAISELONGUE LEFT (or RIGHT) + 2 SEATER RIGHT (or LEFT)

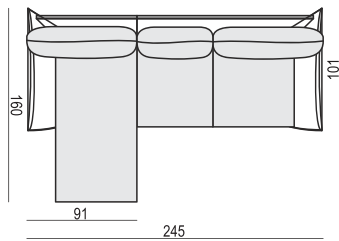

SET 2 LEFT (or RIGHT)
CHAISELONGUE WIDE LEFT (or RIGHT) + 3 SEATER RIGHT (or LEFT)

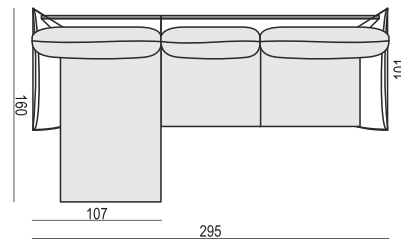

SET 3
3 SEATER LEFT + CORNER 90°
+ 3 SEATER RIGHT

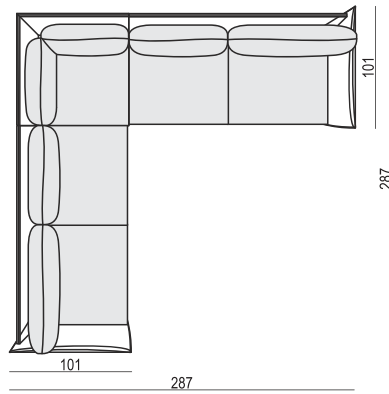

SET 4 LEFT (or RIGHT)
2 SEATER LEFT (or RIGHT) + CORNER 90°
+ 3 SEATER RIGHT (or LEFT)

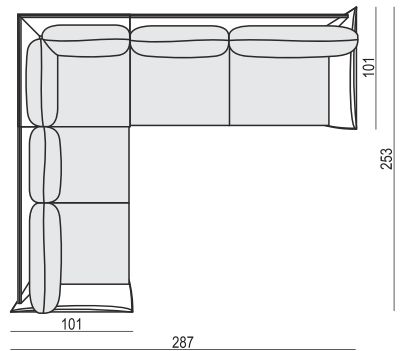

SET 5
2 SEATER LEFT + CORNER 90°
+ 2 SEATER RIGHT

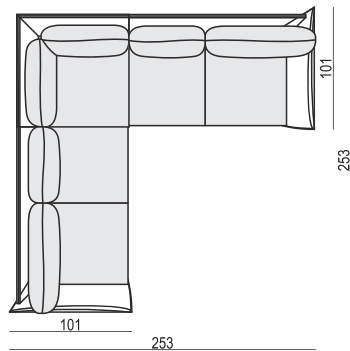

SITS reserves the right to change construction of products and components used due to improving durability of product and customer satisfaction without any further notice. Explicit ± 2 cm tolerance of all elements sizes. Explicit ± 3 cm tolerance between comfort LUX & STD in heights.

UPHOLSTERY FABRIC or LEATHER: FC - fix cover

FEET

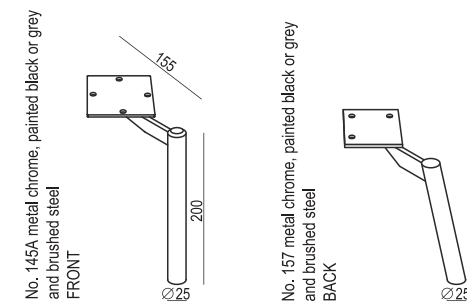

STANDARD COMFORT

1. polyurethane foam/high resilient polyurethane foam
2. silicone balls
3. dynaflex - elastic fabric
4. FSC® certified solid wood and wood based elements
5. fabric or leather
6. painted metal, chrom or brushed legs

CLASSIC COMFORT

1. polyurethane foam / high resilient polyurethane foam
2. foam flakes with silicone balls
3. dynaflex - elastic fabric
4. FSC® certified solid wood and wood based elements
5. fabric or leather
6. painted metal, chrom or brushed legs

LUX COMFORT

1. polyurethane foam/high resilient polyurethane foam
2. cushion chamber with mix of feather and silicone balls
3. dynaflex - elastic fabric
4. FSC® certified solid wood and wood based elements
5. fabric or leather
6. painted metal, chrom or brushed legs