

Sophia

SITS



Sophia

UPHOLSTERY



fabric

COMFORTS



STD standard



LUX lux



CLS classic

COVERS

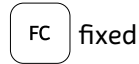

FC fixed

SPECIAL

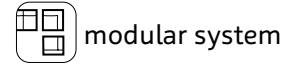

modular system

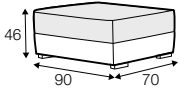

footstool 90x70

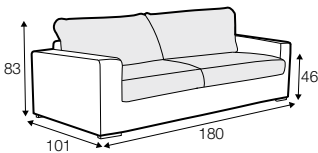

2 seater two cushions

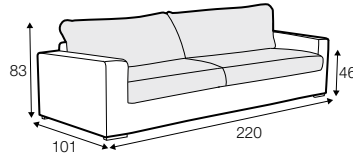

3 seater

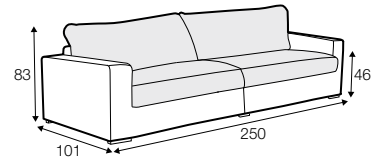

4 seater divided

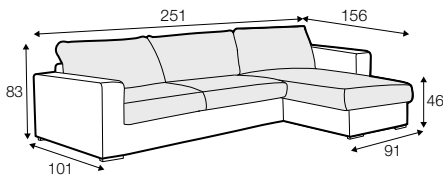

set 1 right / or left
2 seater left / or right
+ chaiselongue right / or left

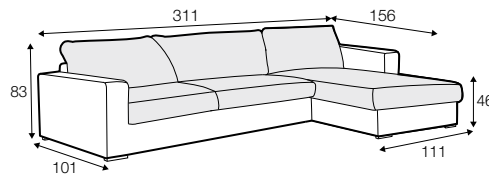

set 2 right / or left
3 seater left / or right
+ chaiselongue wide right / or left

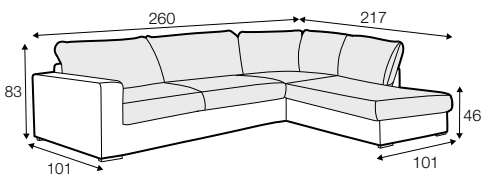

set 3 right / or left
2 seater left / or right + divan right / or left

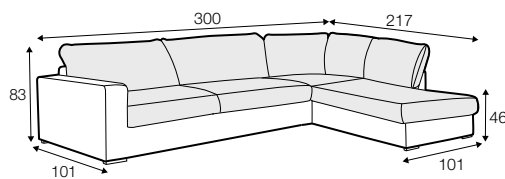

set 4 right / or left
3 seater left / or right + divan right / or left

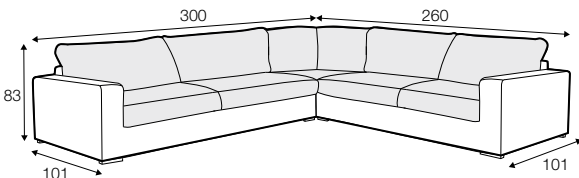

set 5 right / or left
3 seater left / or right + corner 90°
+ 2 seater right / or left

modular system

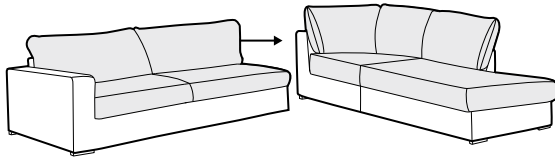

elements of the modular system

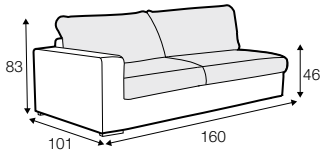

2 seater left / or right

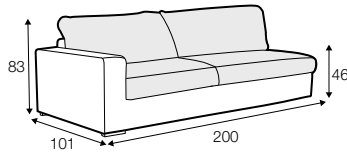

3 seater left / or right

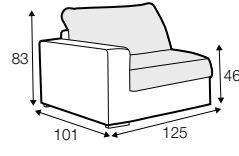

element 125 left / or right

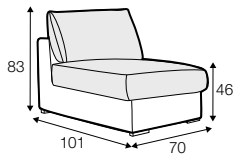

armchair without
armrests

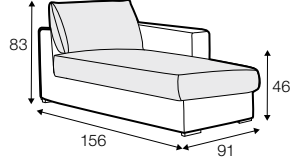

chaiselongue right / or left

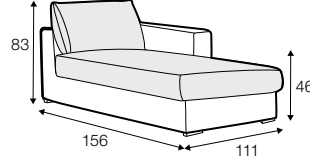

chaiselongue wide
right / or left

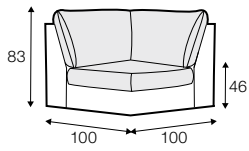

corner 90°

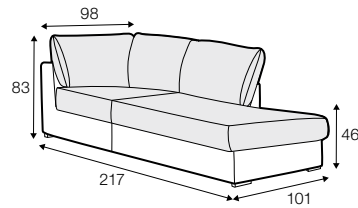

divan right / or left

extra dimensions

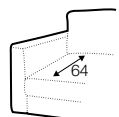

depth of seat

accessories

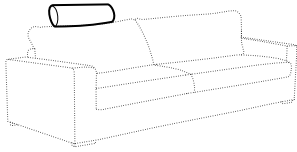

headrest L-62

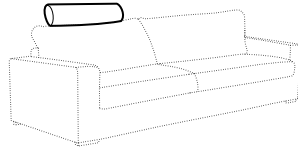
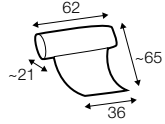

headrest L-77

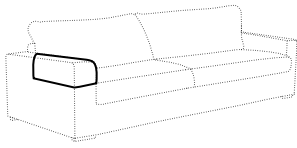
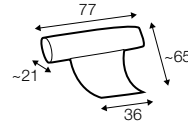

armrest protection

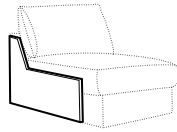

endpart left / or right

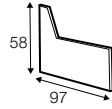

legs

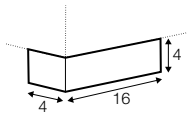

no. 132
wood

profile

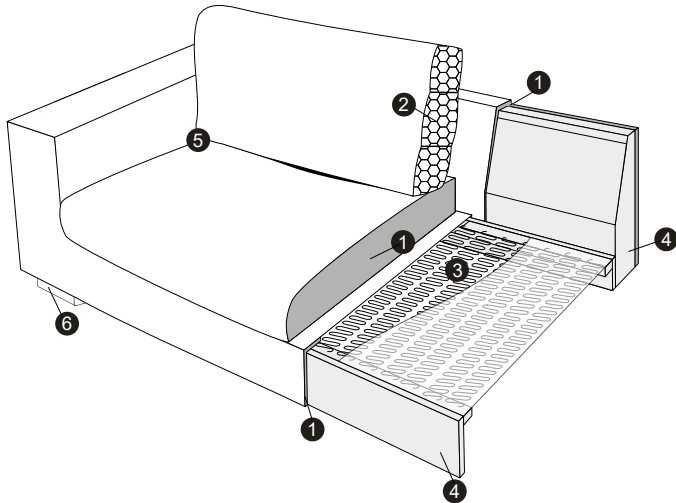

standard

1. polyurethane foam / high resilient polyurethane foam
2. silicone balls
3. springs
4. FSC® certified solid wood and wood based elements
5. fabric
6. solid wood legs

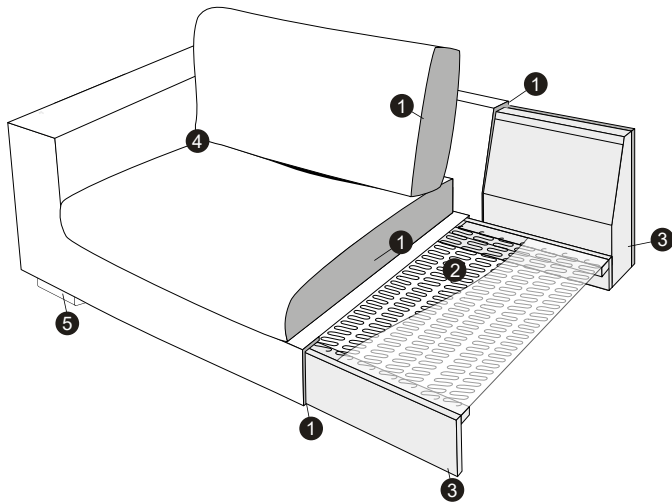

classic

1. polyurethane foam / high resilient polyurethane foam
2. springs
3. FSC® certified solid wood and wood based elements
4. fabric
5. FSC® certified solid wood legs

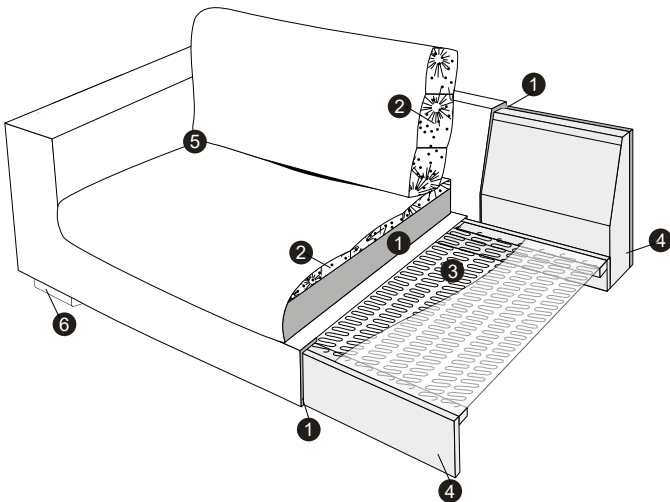

lux

1. polyurethane foam / high resilient polyurethane foam
2. cushion chamber with mix of feather and silicone balls
3. springs
4. FSC® certified solid wood and wood based elements
5. fabric
6. solid wood legs