

Frej

SITS



# Frej

## UPHOLSTERY



fabric



leather

## COMFORTS



STD standard

## COVERS



FC fixed

## SPECIAL



modular system

All elements available in combination fabric and leather.

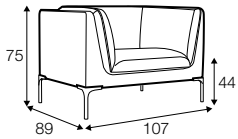

armchair

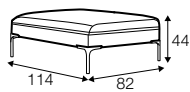

footstool 114x82

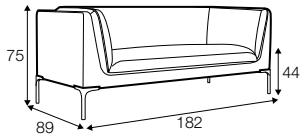

2 seater

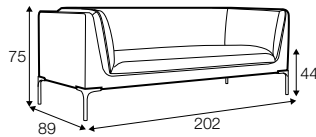

3 seater

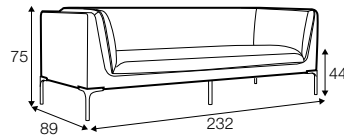

3,5 seater

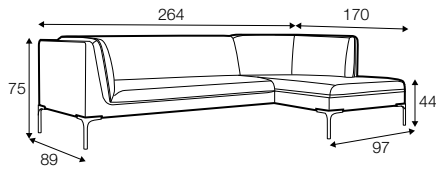

set 1 right / or left

3 seater left / or right + chaiselongue right / or left

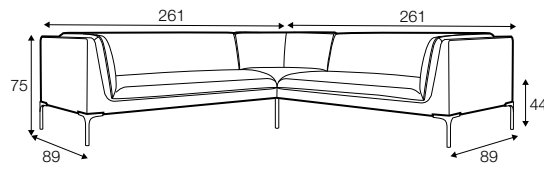

set 2 right / or left

3 seater left / or right + corner 90° + 3 seater right / or left

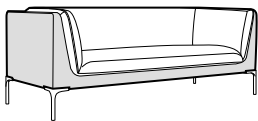

example

mix fabric and leather

## modular system

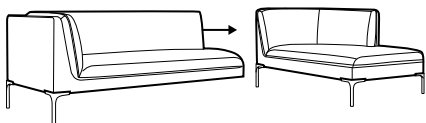

## elements of the modular system

---

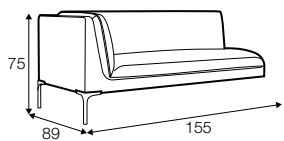

2 seater left / or right

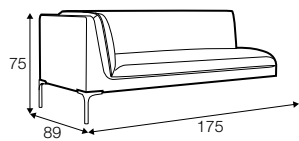

3 seater left / or right

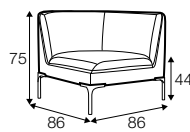

corner 90°

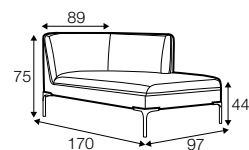

chaiselongue right / or left

## extra dimensions

---

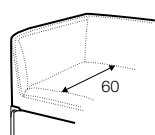

depth of seat

## accessories

---

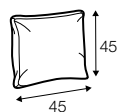

cushion  
45x45

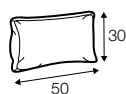

cushion  
50x30

## legs

---

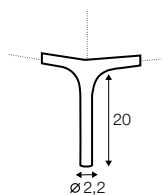

no. 198  
metal chrome,  
painted black or grey,  
brass gold  
and brushed steel

## profile

---

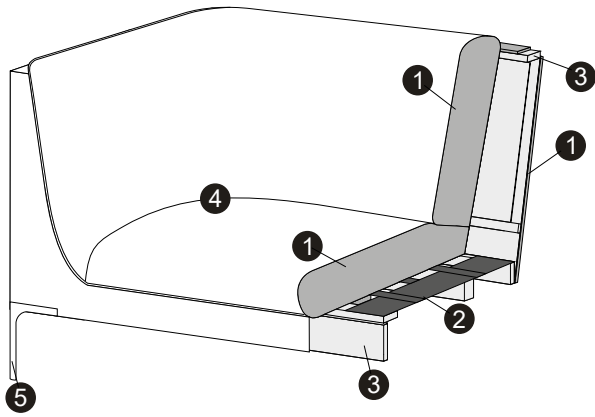

### standard

1. polyurethane foam / high resilient polyurethane foam
2. upholstery belts
3. FSC® certified solid wood and wood based elements
4. fabric or leather
5. metal legs