

SEAT and BACK CUSHIONS

plain



or

quilted

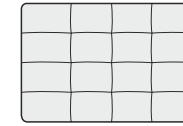

EXAMPLE quilted

2 SEATER with metal legs no.170

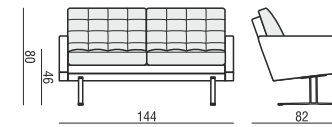

ARMRESTS

wood fabric

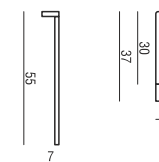

EXAMPLE

ARMCHAIR with WOOD ARMRESTS

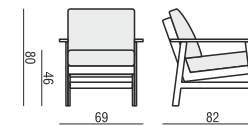

ELEMENT 55 + 2x ARMRESTS

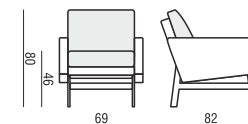

ELEMENT 65 LEFT (or RIHGT)

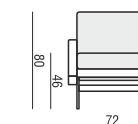

ELEMENT 65 without ARMRESTS

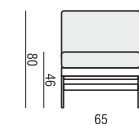

2 SEATER

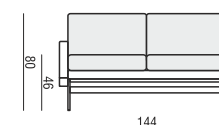

2 SEATER LEFT (or RIGHT)

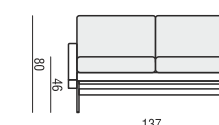

2 SEATER without ARMRESTS

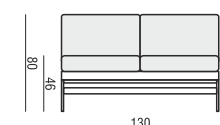

CORNER 90°

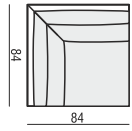

FOOTSTOOL 45x55

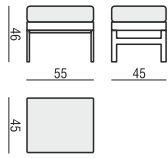

FOOTSTOOL 45x65

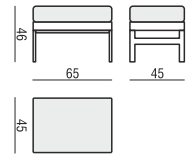

SET 1 LEFT (or RIGHT)

ELEMENT 65 LEFT (or RIGHT) + CORNER 90°
+ 2 SEATER RIGHT (or LEFT)

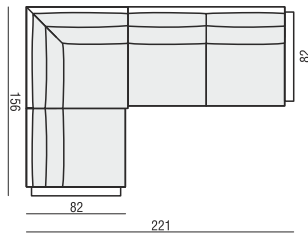

SET 2

2 SEATER LEFT + CORNER 90°
+ 2 SEATER RIGHT

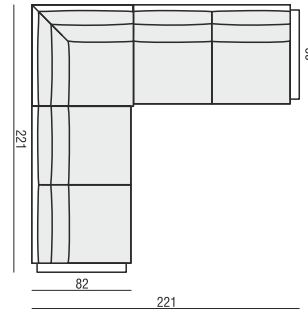

UPHOLSTERY

FABRIC and LEATHER: FC - fix cover

FEET

for fabric or wood armrests
wooden legs

no. 167A - element 55 no. 167C - 2 seater no. 167E - footstool 45x55
no. 167B - element 65 no. 167D - corner 90° no. 167F - footstool 45x65

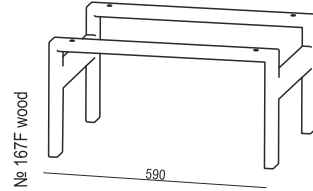
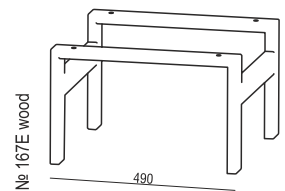
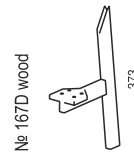
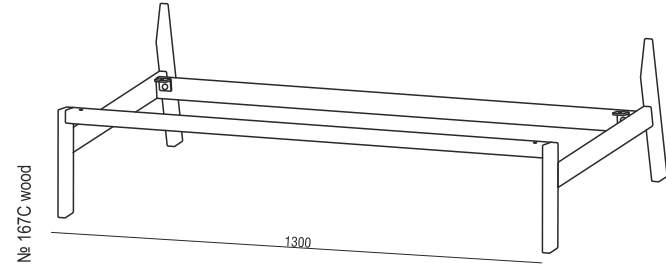
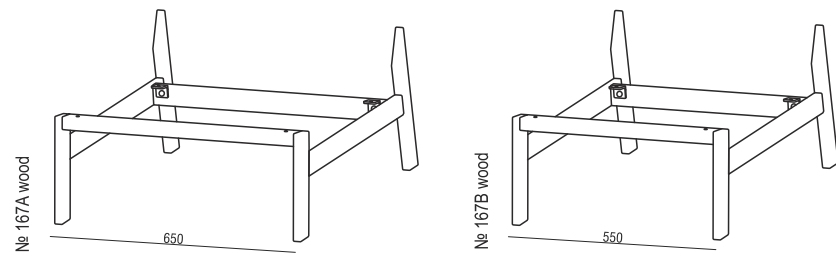

SITS reserves the right to change construction of products and components used due to improving durability of product and customer satisfaction without any further notice. Explicit ±2 cm tolerance of all elements sizes.

FEET

only for fabric armrests
metal legs

no. 168 - elements and sofas
no. 168A - corner 90°
no. 168B - footstool

no. 169 - elements and sofas
no. 169A - corner 90°
no. 169B - footstool

no. 170 - elements and sofas
no. 168A - corner 90°
no. 170B - footstool

No. 168 metal chrome
and painted black or grey

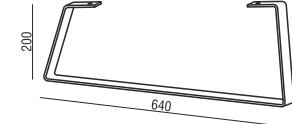

No. 168A metal chrome
and painted black or grey

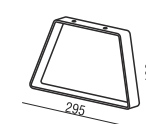

No. 168B metal chrome
and painted black or grey

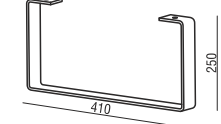

No. 169 metal chrome,
painted black or grey
and brushed steel

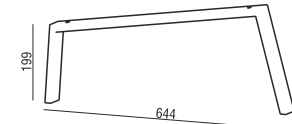

No. 169A metal chrome,
painted black or grey
and brushed steel



No. 169B metal chrome,
painted black or grey
and brushed steel

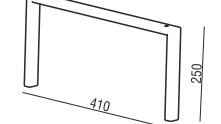

No. 170 metal chrome
and painted black or grey

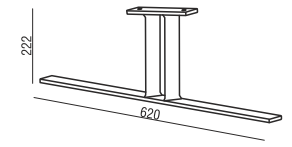

No. 170B metal chrome
and painted black or grey

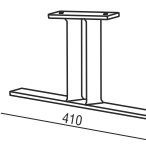

STANDARD COMFORT plain

1. polyurethane foam/high resilient polyurethane foam
2. upholstery belts
3. FSC® certified solid wood and wood based elements
4. fabric or leather
5. FSC certified solid wood or metal legs

STANDARD COMFORT quilted

1. polyurethane foam/high resilient polyurethane foam
2. upholstery belts
3. FSC® certified solid wood and wood based elements
4. fabric or leather
5. FSC certified solid wood or metal legs